



Female Header 2.0mm 1 & 2 Row H=4.0/4.3/4.6mm Straight Type

Specifications

Current Rate: 2.0 AMP
 Insulation Resistance: 1000MΩ Min.
 Contact Resistance: 20mΩ Max.
 Dielectric Voltage: 500V AC for one minute
 Operation Temperature: -40°C to +105°C

Material

Insulator: Polyester, UL 94V-0
 ©Standard: PBT or Nylon 6T
 Terminal: Copper Alloy
 Plating: Gold Plated

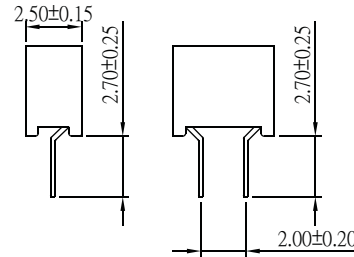
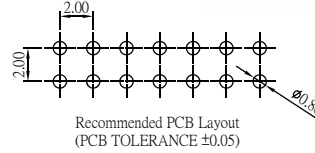
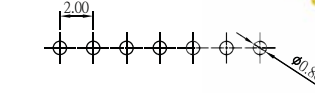
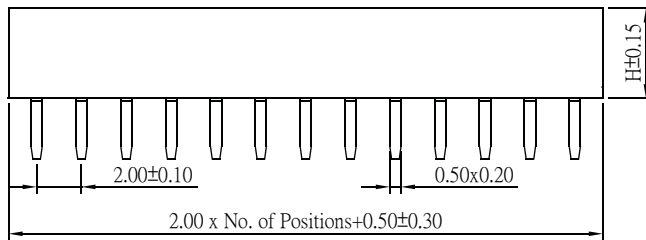
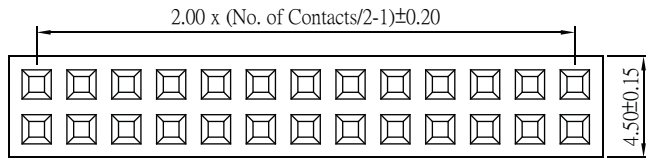
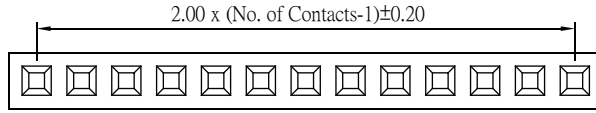
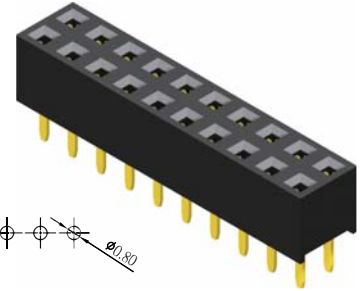

Part No.: PS2S40/43/46-1/2XX-U

Female Header 2.0mm 2 Row H=4.0/4.3mm Straight Type With Bump

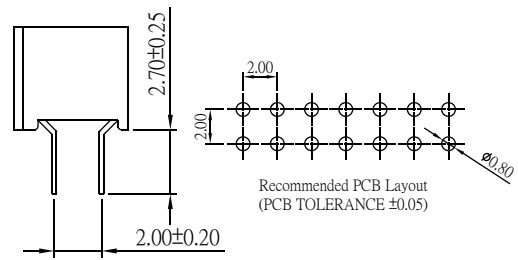
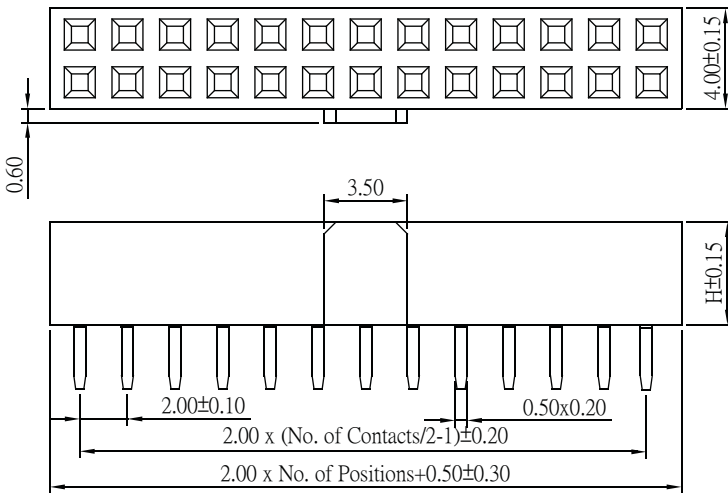
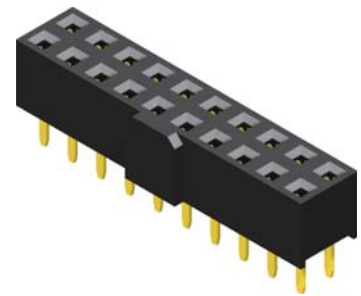

Part No.: PS2SB40/43-2XX-L/U

ORDER INFORMATION

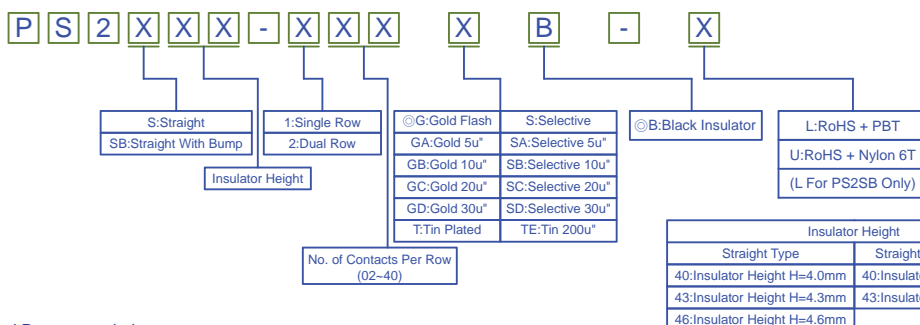

©Standard Recommended

Female Header 2.0mm



RoHS

CONNECTORS MANUFACTURE